

NOTAS GERAIS:

1 - PARA NOTAS GERAIS VER DES. 001.

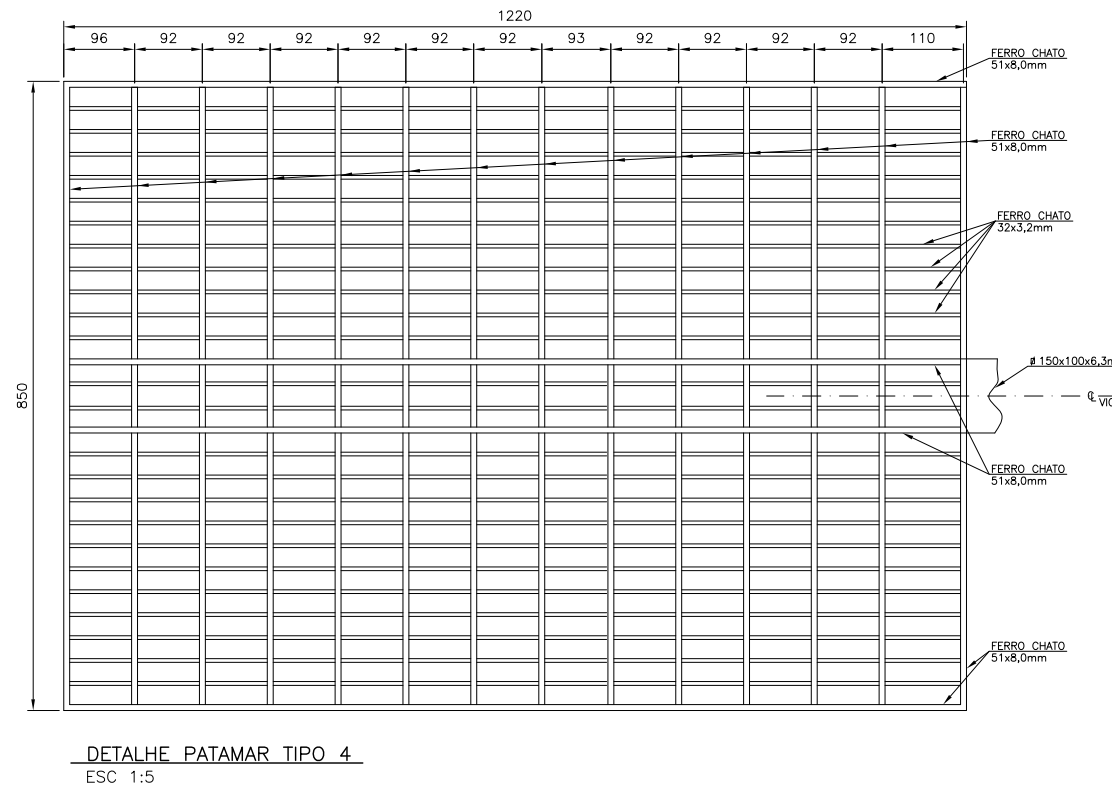
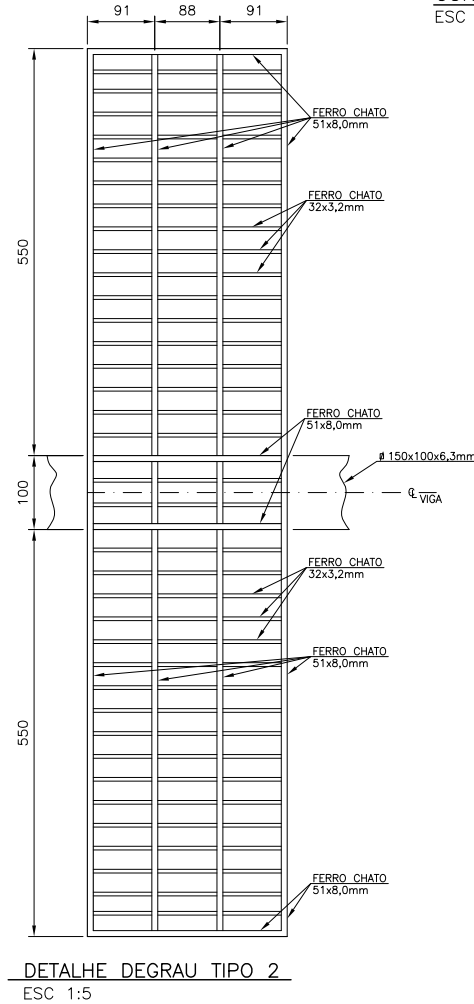
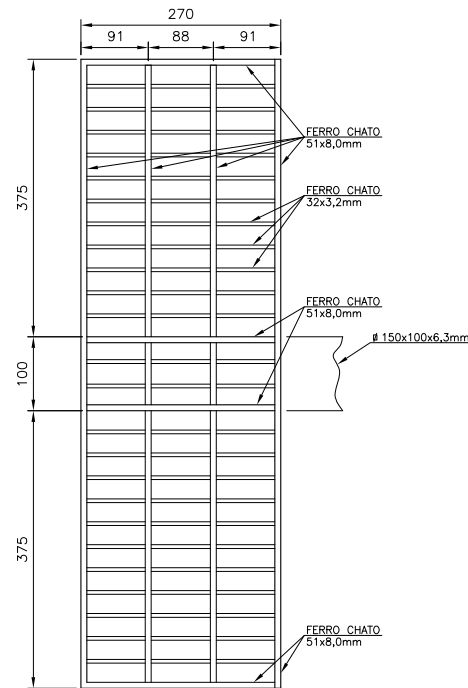
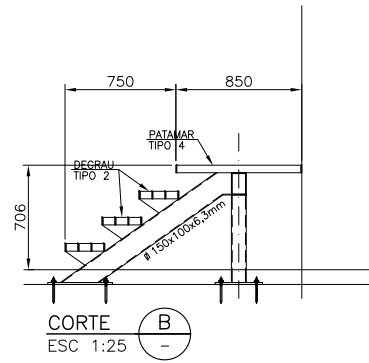
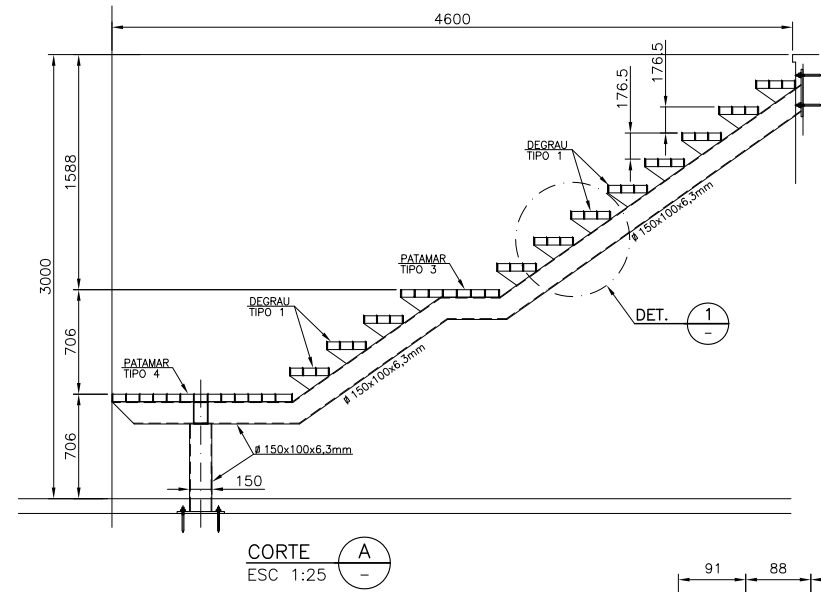
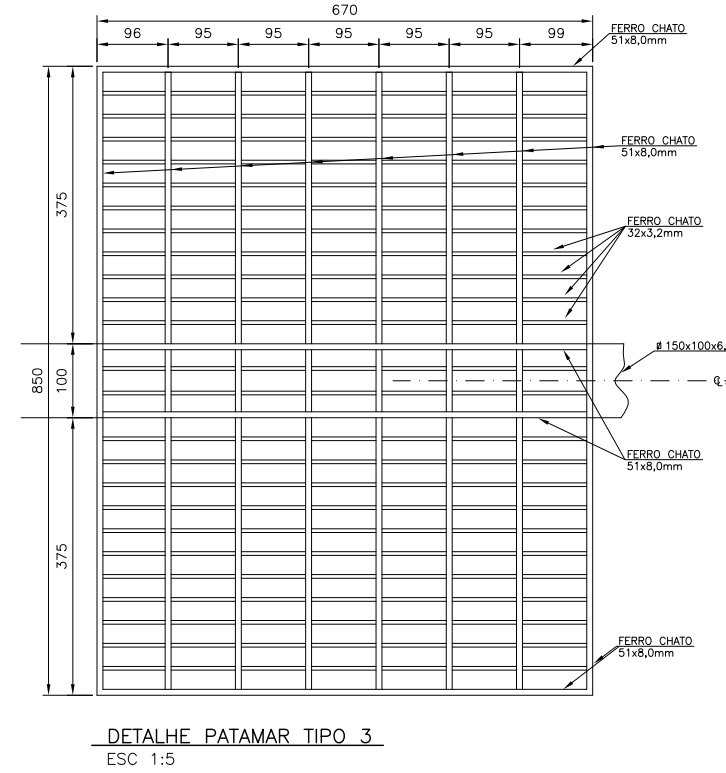
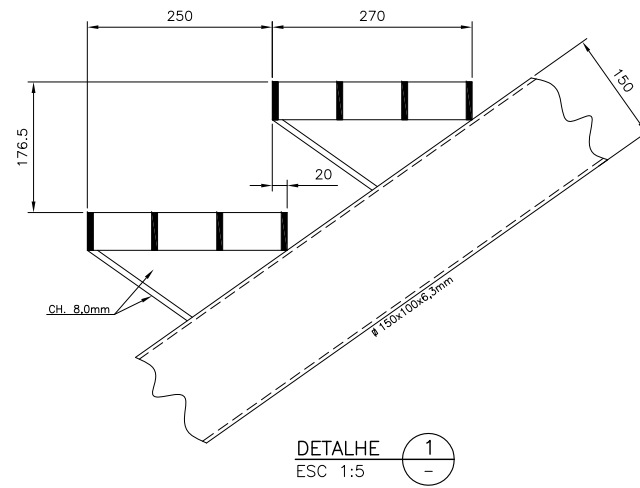
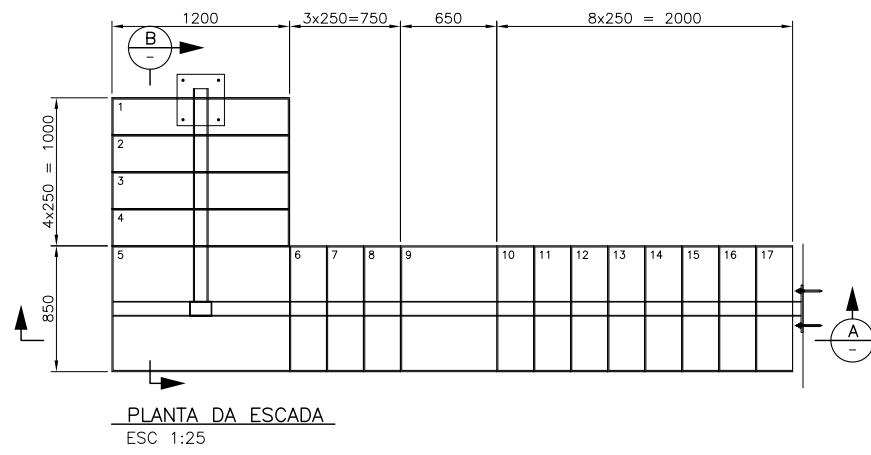

QUADRO DE REVISOES				
REV.	DATA	DESCRICAO	PROJ.	
0	00/00/00	EMISSÃO INICIAL P/ APROVAÇÃO		CRL

LUCCAS PROJETOS
caio@lucasprojetos.com.br
11-98181-5044

CLIENTE:

OBRAS: **ESCADA METÁLICA LUC - 000000** LOCAL: **SÃO PAULO - SP**

TITULO: **PROJETO UNIFILAR - ESTRUTURA METÁLICA CORTES E DETALHES** FOLHA: **01/01**

RESPONSÁVEL: **ENG. CAIO R. LUCCAS** CREA: **5062521935** ART:

ESCALA: **IND.** PROJ. **CRL** DES. **CRL** NOME ARQUIVO: **LP-10000-001-00** REV. **00**

DADOS PARA PLOTAGEM			
ESC.	PLOT.	PER.	NOTA
1	7	0.10	
2	7	0.20	
3	7	0.30	
4	7	0.40	
5	7	0.50	
6	7	0.60	
7	7	0.10	
8	7	0.05	
11	7	0.05	
12	7	10%	
66	7	10%	

FORMATOS:
A1 A1L A0
84/204/118/204/118/84
NOME DO ARQUIVO:
- DWG